

# SAVE ENERGY

LIGHTING LIFESTYLE

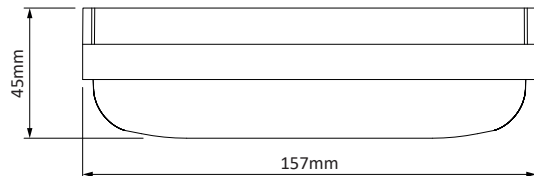
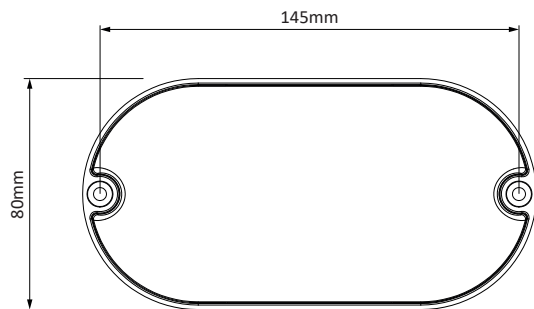

MANUAL DE INSTALAÇÃO

## BLINDADO LED 8W 85-240V (BIVOLT)



IP65



Bivolt  
(85-240V)



Garantia

SAC 0800 750 5592  
sac@save.com.br  
www.save.com.br  
f @ saveenergylife



REV00

SAVE  
LIGHTING  
LIFESTYLE

LEIA ATENTAMENTE AS INSTRUÇÕES ANTES DE INSTALAR

Desligue a energia elétrica antes da instalação (ou quando realizar manutenção/limpeza), evitando choque elétrico.

- 1** Certifique-se de que a rede elétrica esteja desligada e conecte os fios do Blindado LED à rede elétrica.

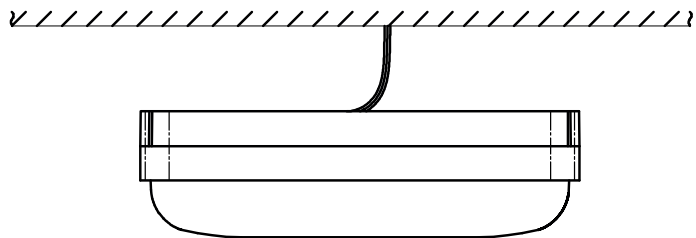

**FIO MARROM  
FASE**

**FIO AZUL  
NEUTRO**

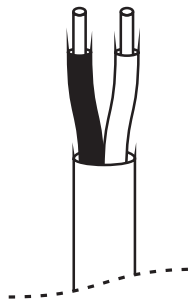

**Atenção:**  
Isole adequadamente as emendas sem deixar fios expostos.

- 2** Posicione o Blindado LED no local da instalação e marque os pontos de furação. Fure os pontos marcados com broca 6mm e insira as buchas do kit de fixação.

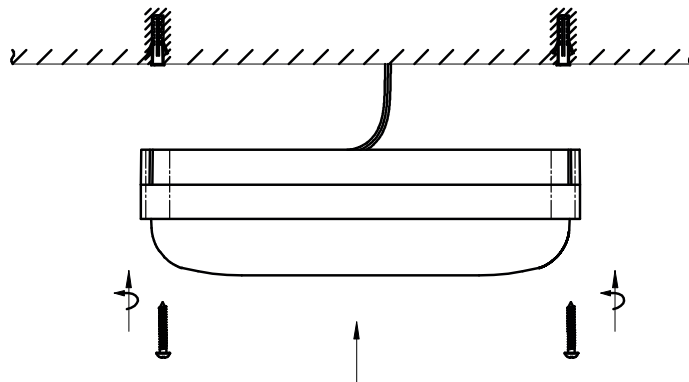

Faça a fixação do Blindado LED utilizando os parafusos.

## Lista de Componentes

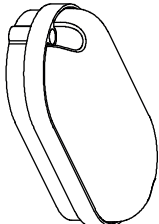
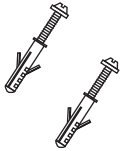
Figura		
Item	Blindado LED	Parafuso M4x30
Quantidade	1	2