

EMBUTIDO HIDE

SAVEENERGY
LED AUTHORITY

EFEITO DE LUZ
OCULTA
ANTI-GLARE

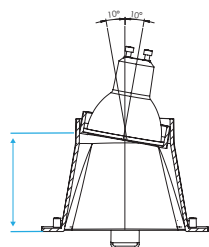

INSTALAÇÃO
ATRAVÉS DE
MOLAS

* Molas Inclusas

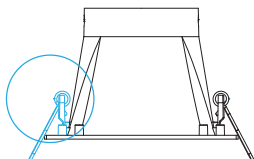

COMPATÍVEL
COM LÂMPADA
DICRÓICA

MR16

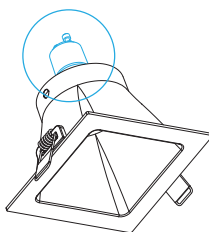

Possui **RECUO APROFUNDADO**, aumentando o conforto visual e reduzindo o ofuscamento

| SKU | COR |
|-------------|-----|
| SE-330.1594 | ● |
| SE-330.1593 | ○ |
| SE-330.1595 | ◐ |

LÂMPADA VENDIDA SEPARADAMENTE.

SOQUETE GU10 INCLUSO.

DESENHOS TÉCNICOS

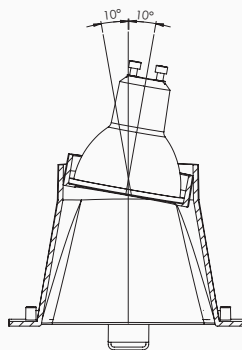
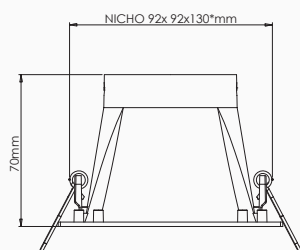
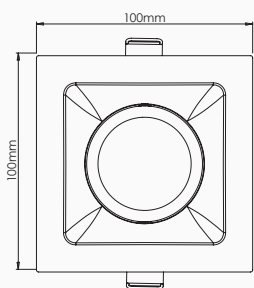

Possibilita ajuste de angulação de 10°

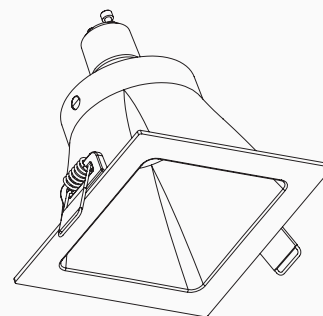

*A profundidade do nicho pode variar de acordo com o modelo e marca da lâmpada utilizada.

UTILIZAR SOMENTE COM LÂMPADAS LED



ISO 9001:2015
FÁBRICA CERTIFICADA

FEITONOBASIL
Gera Empregos - Gera Segurança - Gira a Economia.