

MANUAL DE INSTALAÇÃO

CONECTOR PARA FITA LED 12V

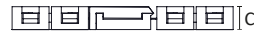

Modelo	Dimensões (A x B x C)
CONECTOR FONTE x FITA - 2 FIOS PARA FITA LED 8MM	160x13x5mm
CONECTOR FITA x FITA - TIPO EMENDA PARA FITA LED 8MM	15,5x13x5mm
CONECTOR FITA x FITA - TIPO "L" PARA FITA LED 8MM	28x28x5mm
CONECTOR FITA x FITA - TIPO "T" PARA FITA LED 8MM	44x28x5mm

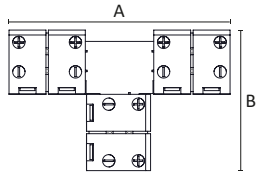
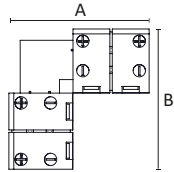
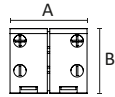
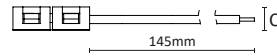
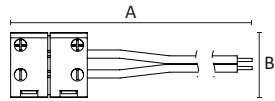

LEIA ATENTAMENTE AS INSTRUÇÕES ANTES DE INSTALAR

Desligue a chave geral de energia antes da instalação (ou quando realizar manutenção/limpeza), evitando choque elétrico.

Encaixar a Fita 12V abaixo dos terminais do conector, o polo positivo da fita (+) deve ser conectado no polo positivo do conector (+), o polo negativo (-) deve ser conectado no polo negativo do conector (-). Finalize instalação fechando o conector.

Verifique abaixo as variações de modelos:

CONECTOR FONTE x FITA - 2 FIOS PARA FITA LED 8MM

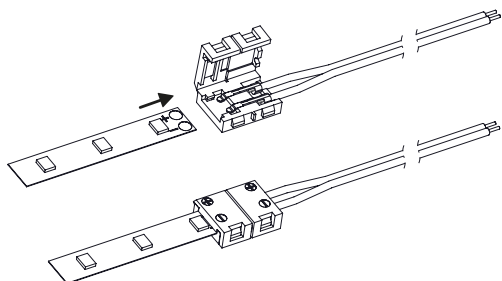

Obs.: Para esse modelo, conectar os fios a uma fonte 12V DC de acordo com a polaridade correspondente.

CONECTOR FITA x FITA - TIPO EMENDA PARA FITA LED 8MM

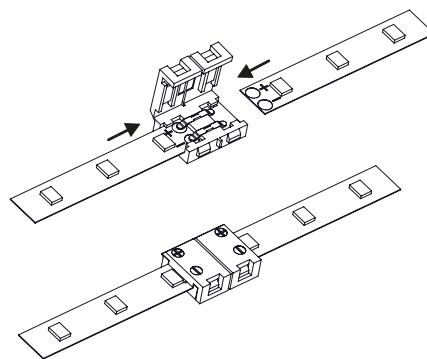

CONECTOR FITA x FITA - TIPO "L" PARA FITA LED 8MM

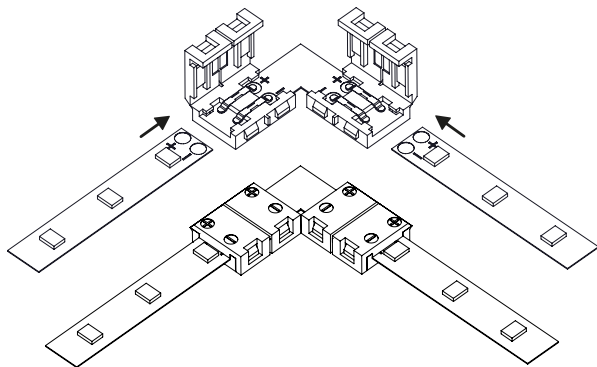

CONECTOR FITA x FITA - TIPO "T" PARA FITA LED 8MM

